

SYSTEMATIC QUALITY

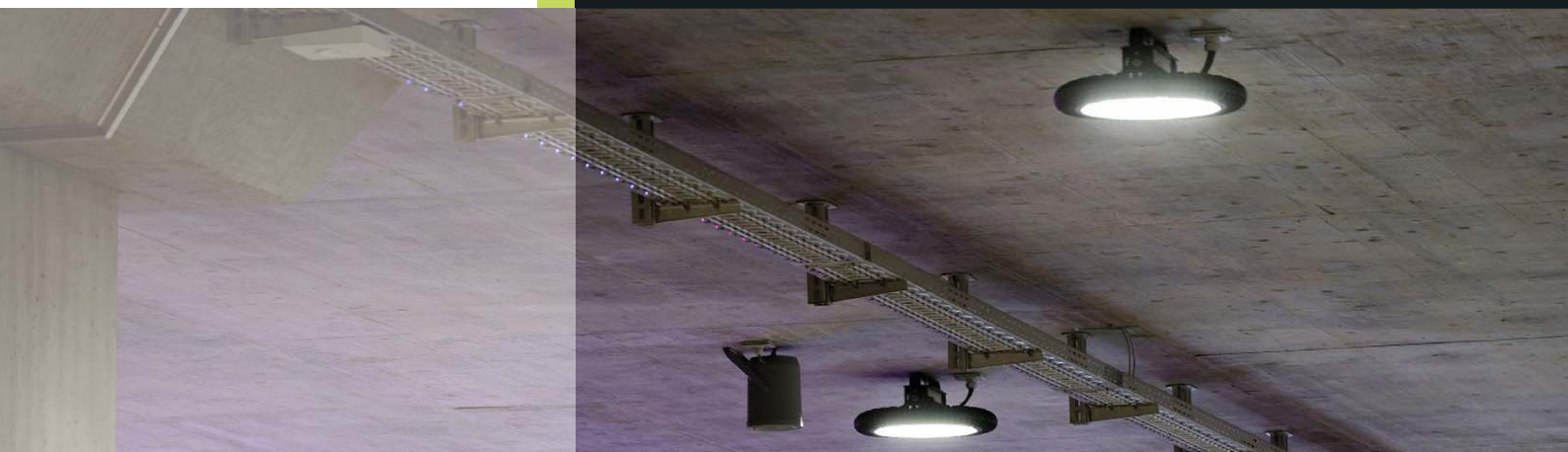

Hall lighting Area lighting

LED spotlights for indoor and outdoor



LED Pendant light / LED Hall lighting

Page 4 - 10

DeltaLUXX DeltaLUXX 2HT



Page 8 - 9



Page 10

LED Floodlight AlphaLuxx

Page 14 - 20

AlphaLUXX
25-60



Page 18

AlphaLUXX
80-120



Page 19

AlphaLUXX
80-120
Ball-proof



Page 20

LED Floodlight PLAZA FlatLED

Page 22 - 32

PLAZA FlatLED
FLOOD 16W



Page 25

PLAZA FlatLED
FLOOD 24W



Page 26

PLAZA FlatLED
FLOOD 48W



Page 27

PLAZA FlatLED
FLOOD 72W



Page 28

PLAZA FlatLED
FLOOD 150W



Page 29

Wall bracket for
PLAZA FlatLED



Page 30

Application examples

LED Pendant
light



Page 11 - 13

LED Floodlight
AlphaLUXX

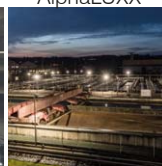

Page 21

LED Floodlight
PLAZA FlatLED



Page 30 - 31





LED Pendant light
LED Hall lighting

DeltaLUXX - General



- ✓ Made in Germany
- ✓ For applications with high light points
- ✓ Sleek, modern industrial design
- ✓ Optional with optics for a wide range of applications
- ✓ Approved for fire endangered premises (D-Label)

The new hall deflector from GIFAS impresses with design and flexibility. The efficient thermal management of this hall light, which ensures a permanently adequate cooling even in dust and dirt-contaminated areas, supports the current and efficient LED technology with a service life of at least 80.000 hours. The DeltaLUXX can be integrated into intelligent lighting systems by means of optional DALI and 1-10V dimming interfaces.

On the basis of high-performance LEDs, the DeltaLUXX demonstrates its enormous luminaire efficiency, particularly in areas with high luminous intensity that are difficult to illuminate. With an external diameter of 450 millimeters, 180 high-end LEDs and high-quality individual optics with various different radiation characteristics, it is possible to be used in halls up to 25 meters high.

With its aluminum die-cast housing, a special PTFE non-stick coating for minimized dust and dirt adhesion, a pressure compensation diaphragm and the use of robust polycarbonate discs with increased splinter protection or toughened safety glass, the DeltaLUXX ensures reliable operation in ambient temperatures of up to 60 ° Celsius.

The design is convincing with modern industrial design and slim shapes.

DeltaLUXX - Construction / Features

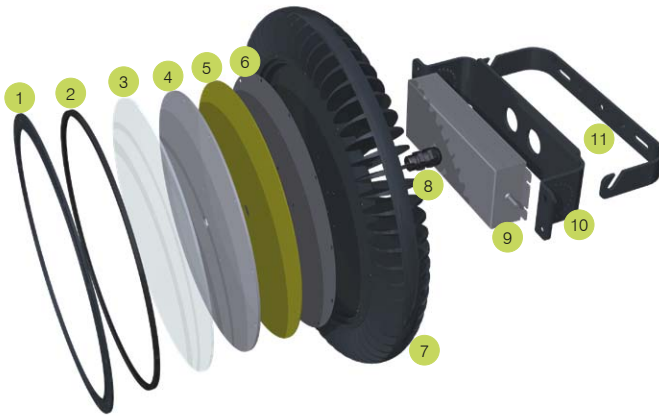

- 1 Die-cast aluminium frame
- 2 U-profile silicon seal
- 3 Front panel (PC or toughened glass)
- 4 Optic
- 5 LED board
- 6 Heat conducting film
- 7 Die-cast aluminium housing
- 8 Cable gland with pressure compensation function
- 9 Power supply
- 10 Power supply bracket
- 11 Mounting bracket

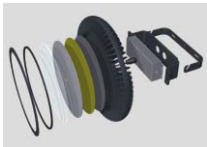

GIFAS Approach

The basis of this development is based on the necessity of producing a high bay light that earns the **MADE IN GERMANY** quality seal in terms of performance and quality. The DeltaLUXX has succeeded in developing a competitive LED

high bay light that meets the highest demands and is also used safely in demanding industries.



Future-proof

The DeltaLUXX impresses with its **enormous system efficiency and high quality of light**. With optional DALI and 1-10V dimming interfaces, the DeltaLUXX can be integrated into intelligent lighting systems. Use in sensor-controlled

systems (light or presence detector) and opens up further energy-saving potential.



Modern

For the DeltaLUXX, only **high-end SMD** LEDs from well-known manufacturers are used, which are optimally matched to the parameters of light quality, service life, light color and efficiency. High-quality individual optics are installed for efficient

light distribution.



Highest quality

The components are selected to the highest quality standards: high-alloyed, corrosion-resistant aluminum housing, LEDs, mounting material made of stainless steel (V4A) and electronics from well-known manufacturers.

Individual test of each luminaire according to DIN EN 60598-1, certified according to ENEC.



Robust

Industrial lights often show the problem of surface contamination and the associated cooling performance reduction. The **PTFE surface coating (ugs Teflon®)** of the DeltaLUXX has a very low coefficient of friction. Dust and dirt

literally „pearl“ away from the luminaire. Even aggressive acids cannot attack the PTFE coating. The required thermal conductivity is due to the four times thinner PTFE coating, compared to the powder coating, given permanently.



Long life

Efficient cooling is essential to the life of the LEDs and ultimately affects the whole lighting system. In order to sustainably achieve this for the DeltaLUXX, high-quality technical components with a sophisticated design have been combined.

The outer open ring ensures even with a high degree of contamination for the dissipation of heat generated. The design in conjunction with a very thin coating, heat-conducting foil for optimum connection of the contact surfaces, results in a **operating temperature range of up to 60 ° Celsius and a service life of at least 80,000 hours.**

DeltaLUXX



Product features

- Robust housing made of corrosion-resistant die-cast aluminium
- Dirt-resistant PTFE surface coating, approved for the food industry
- 3mm impact resistant plastic cover (PC) or 3mm toughened safety glass (ESG)
- Custom-made U-profile seal surrounding all sides
- Custom-made, durable, heat-conducting film for lasting, reliable dissipation of heat from the LED board
- Low heat generation thanks to the latest LED technology
- Pressure compensation element for extreme temperature fluctuations
- Full luminous flux is available instantly after switching on
- Low energy consumption with high light output
- Maintenance-free
- Wide operating temperature range (up to 60°C)
- No UV/IR-radiation
- Vibration-resistant
- Accessories available from stock
- Various directional characteristics available

Technical data

Operating Voltage	100-277VAC (50/60Hz)
Illuminant	SMD-LEDs
System performance:	
DeltaLUXX 2	95W / 140W / 183W / 225W / 270W
DeltaLUXX	164W / 215W / 264W
Luminous flux:	
DeltaLUXX 2	16.400lm / 22.400lm / 28.100lm / 32.400lm / 38.900lm
DeltaLUXX	18.817lm / 23.313lm / 26.676lm
System Efficiency:	
DeltaLUXX 2	173lm/W / 160lm/W / 154lm/W / 147lm/W / 144lm/W
DeltaLUXX	137lm/W / 131lm/W / 123lm/W
Light color	5.000K
CRI-Index	Ra >80
Beam Beam Angle	open distribution 120° optics 75° / 50°
L70/B10	> 80.000h
Type of protection light	IP65
Protection class	I
Shock resistance	IK08 (*for the version with PC cover)
Temperature range for operation	90W/100W -30°C to +65°C 130W -30°C to +60°C 170W -30°C to +55°C 200W - 30°C to +50°C 250W -30°C to +45°C
Max. surface temperature	+90°C (suitable for use in industrial premises with fire hazards) D-rating label
Housing material	Die-cast aluminium
Housing surface	PTFE-coated (approved for the food industry)
Housing color	black
Cover	3 mm ESG (vision), 3 mm polycarbonate
Connection cables	1 m
Weight	approx. 9,5 kg
Dimensions Ø x H	450 x 195 mm
Certification	ENEC, CB, CE, D-rating label

DeltaLUXX with optics

DeltaLUXX open distribution

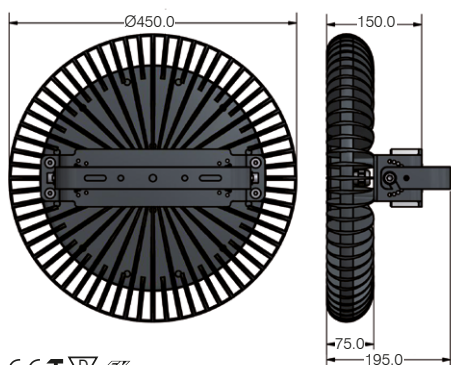
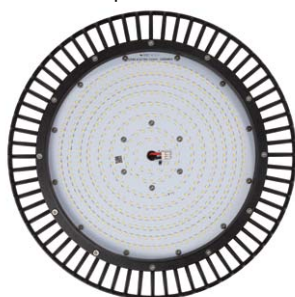
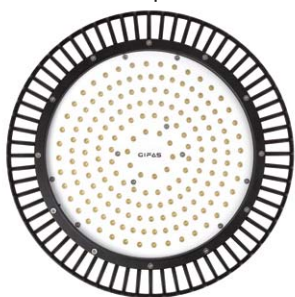

DeltaLUXX - Assortment / Light distributor

DeltaLUXX 2		
EDP No.	Product-ID-No.	Description
800287	DELTALUXX.2.90W.230V.120°.PC.KLAR	LED-spotlights 100-240VAC, 90W, IP65, 5.000K, 15.700lm, cover PC 3 mm, clear
800288	DELTALUXX.2.90W.230V.120°.ESG.KLAR	LED-spotlights 100-240VAC, 90W, IP65, 5.000K, 16.400lm, cover ESG 3 mm, clear
800289	DELTALUXX.2.130W.230V.120°.PC.KLAR	LED-spotlights 100-240VAC, 130W, IP65, 5.000K, 21.400lm, cover PC 3 mm, clear
800290	DELTALUXX.2.130W.230V.120°.ESG.KLAR	LED-spotlights 100-240VAC, 130W, IP65, 5.000K, 22.400lm, cover ESG 3 mm, clear
800291	DELTALUXX.2.170W.230V.120°.PC.KLAR	LED-spotlights 100-240VAC, 170W, IP65, 5.000K, 26.800lm, cover PC 3 mm, clear
800292	DELTALUXX.2.170W.230V.120°.ESG.KLAR	LED-spotlights 100-240VAC, 170W, IP65, 5.000K, 28.100lm, cover ESG 3 mm, clear
800293	DELTALUXX.2.200W.230V.120°.PC.KLAR	LED-spotlights 100-240VAC, 200W, IP65, 5.000K, 31.000lm, cover PC 3 mm, clear
800294	DELTALUXX.2.200W.230V.120°.ESG.KLAR	LED-spotlights 100-240VAC, 200W, IP65, 5.000K, 32.400lm, cover ESG 3 mm, clear
800295	DELTALUXX.2.250W.230V.120°.PC.KLAR	LED-spotlights 100-240VAC, 250W, IP65, 5.000K, 37.530lm, cover PC 3 mm, clear
800296	DELTALUXX.2.250W.230V.120°.ESG.KLAR	LED-spotlights 100-240VAC, 250W, IP65, 5.000K, 38.900lm, cover ESG 3 mm, clear

Light intensity distribution at 120°

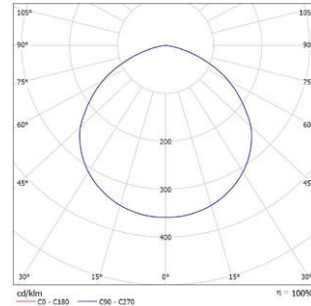

DeltaLUXX		
EDP No.	Product-ID-No.	Description
800121	DELTALUXX.150W.230V.75°.PC.KLAR	LED spotlights 100-240VAC, 150W, IP65, 5.000K, 18.118lm, cover PC 3 mm, clear
800122	DELTALUXX.200W.230V.75°.PC.KLAR	LED spotlights 100-240VAC, 200W, IP65, 5.000K, 22.543lm, cover PC 3 mm, clear
800123	DELTALUXX.240W.230V.75°.PC.KLAR	LED spotlights 100-240VAC, 240W, IP65, 5.000K, 25.933lm, cover PC 3 mm, clear

Light intensity distribution at 75°

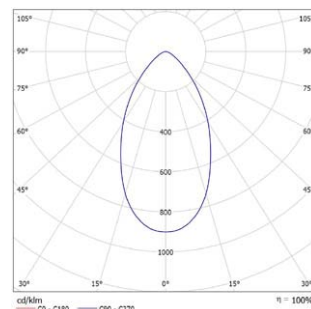

DeltaLUXX		
EDP No.	Product-ID-No.	Description
800118	DELTALUXX.150W.230V.50°.PC.KLAR	LED spotlights 100-240VAC, 150W, IP65, 5.000K, 18.817lm, cover PC 3 mm, clear
800119	DELTALUXX.200W.230V.50°.PC.KLAR	LED spotlights 100-240VAC, 200W, IP65, 5.000K, 23.313lm, cover PC 3 mm, clear
800120	DELTALUXX.240W.230V.50°.PC.KLAR	LED spotlights 100-240VAC, 240W, IP65, 5.000K, 26.676lm, cover PC 3 mm, clear

Light intensity distribution at 50°

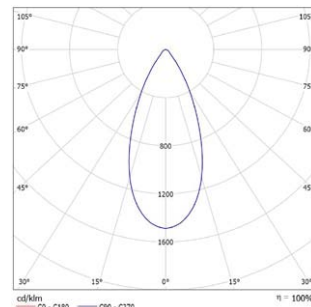

Accessories		
EDP No.	Product-ID-No.	Description
123867	ALPHALUXX-TEETUBE. KABELVERBINDER. 3P.16A.400V.IP68	Cable connector THB.391. A3A, PA66GF, screw terminals 0.5-2.5 mm², for cables 7-12 mm Connection connection 3-pin 2/3/4

DeltaLUXX 2 HT high temperature spotlight

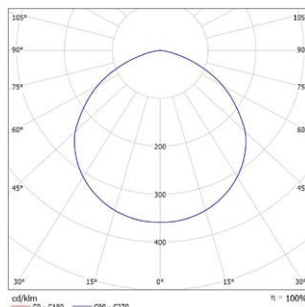

Product features

- Robust housing made of corrosion-resistant die-cast aluminium
- Dirt-resistant PTFE surface coating, approved for the food industry
- 3mm impact resistant plastic cover (PC)
- Custom-made U-profile seal surrounding all sides
- Custom-made, durable, heat-conducting film for lasting, reliable dissipation of heat from the LED board
- Low heat generation thanks to the latest LED technology
- Pressure compensation element for extreme temperature fluctuations
- Full luminous flux is available instantly after switching on
- Low energy consumption with high light output
- Maintenance-free
- Wide operating temperature range (up to 70°C)
- No UV/IR-radiation
- Vibration-resistant
- Accessories available from stock

Technical data

Operating Voltage	100-277VAC (50/60Hz)
Illuminant	SMD-LEDs
System performance	140W / 183W
Luminous flux	21.400lm / 26.800lm
System Efficiency	153lm/W / 147lm/W
Light color	5.000K
CRI-Index	Ra >80
Beam Beam Angle	open distribution 120°
L70/B10	> 50.000h
Type of protection light	IP65
Protection class	I
Shock resistance	IK08
Temperature range for operation	-30°C bis +70°C
Housing material	Die-cast aluminium
Housing surface	PTFE-coated (approved for the food industry)
Housing color	black
Cover	3 mm polycarbonate
Connection cable	1 m
Weight	approx. 9,5 kg
Dimensions Ø x H	450 x 195 mm
Certification	CE

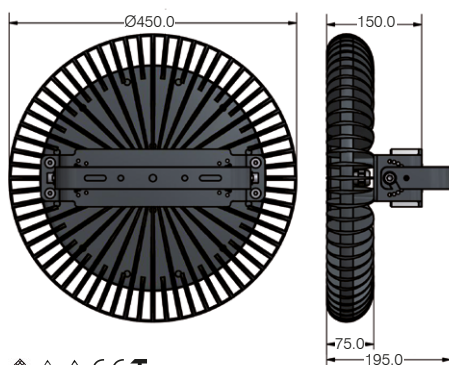
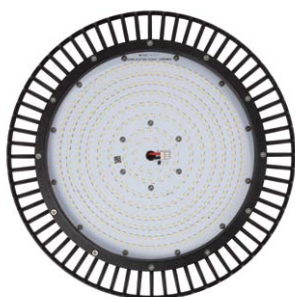

DeltaLUXX 2 HT		
EDP No.	Product-ID-No.	Description
800389	DELTALUXX.2.130W.230V.120°.PC.KLAR.HT	LED spotlights high temperature 100-240VAC, 130W, IP65, 5.000K, 21.400lm, cover PC 3 mm, clear
800390	DELTALUXX.2.170W.230V.120°.PC.KLAR.HT	LED spotlights high temperature 100-240VAC, 170W, IP65, 5.000K, 26.800lm, cover PC 3 mm, clear

LED Pendant light / Hall lighting - DeltaLUXX 2 HT high temperature spotlight



DeltaLUXX 2 HT - Lighting steel industry



DeltaLUXX 2 HT - Lighting salt works

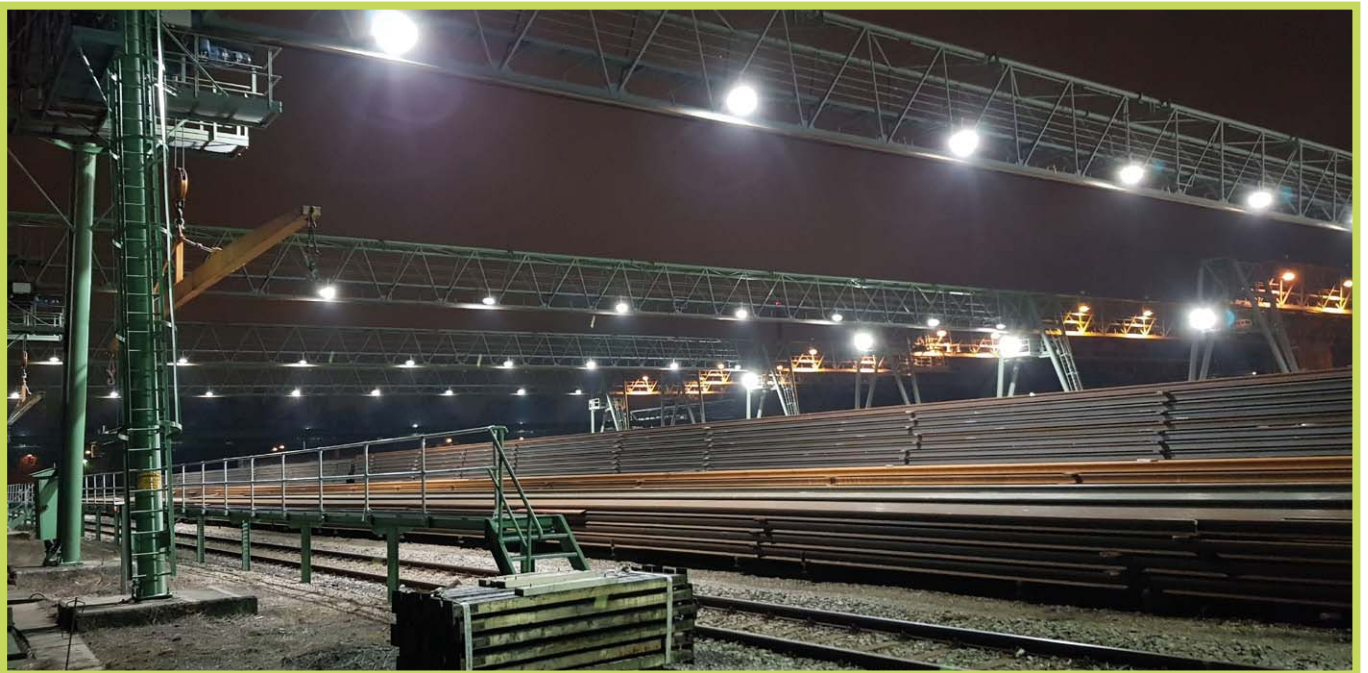

DeltaLUXX 2 HT - Track loading lighting

LED Pendant light / Hall lighting - DeltaLUXX



DeltaLUXX - Train station lighting



DeltaLUXX - Warehouse lighting



DeltaLUXX Blue - Outdoor sewage treatment plant lighting



DeltaLUXX - Driving safety center lighting



DeltaLUXX Blue - Facade lighting

LED Pendant light / Hall lighting - DeltaLUXX



DeltaLUXX - Storage space lighting



DeltaLUXX - Cable car lighting



DeltaLUXX - Hall lighting in a foundry



DeltaLUXX - Snow grooming workshop lighting





LED Floodlight AlphaLUXX



AlphaLUXX General



AlphaLUXX 25-60
AlphaLUXX 80-120

- ✓ Made in Germany
- ✓ Revolutionary PTFE surface coating
- ✓ Optional in vibration-damped design
- ✓ Approved for fire endangered premises (D-Label)
- ✓ Suitable for food industry (according to IFS)

The AlphaLUXX floodlight is 100% **Made in Germany**. During the development, great emphasis was placed on the quality of the components, coupled with excellent efficiency and state-of-the-art technology.

Short response times at the **Neuss production plant** are guaranteed, meaning we are able to meet customer requirements promptly in terms of different outputs and front panels, various cable lengths and special color designs.

AlphaLUXX 80-120

The Lamp impresses with the enormous efficiency and is also available in a dimmable version.

AlphaLUXX 25-60

The AlphaLUXX 25-60 is the practical version for mobile use and convinces with its quality, performance and handling.

AlphaLUXX - Construction / Features

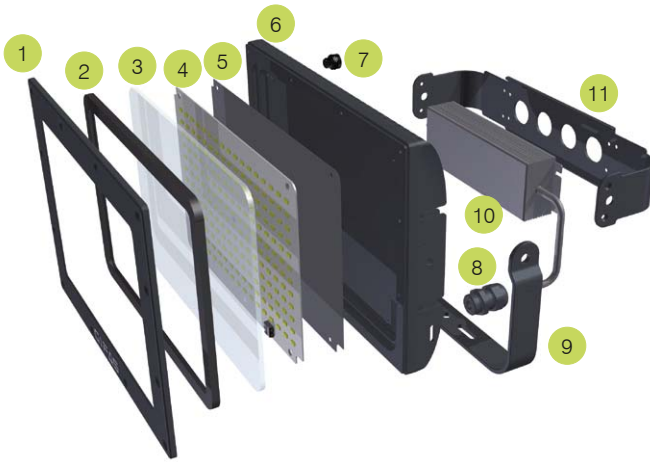

- 1 Die-cast aluminium frame
- 2 U-profile silicon seal
- 3 Front panel (toughened glass or PC)
- 4 LED board
- 5 Heat conducting film
- 6 Die-cast aluminium housing
- 7 Pressure compensation element
- 8 Cable gland
- 9 Mounting bracket
- 10 Power supply
- 11 Power supply bracket

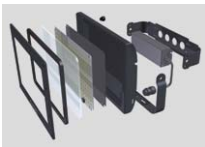

GIFAS Approach

This development is based on the need to manufacture a floodlight which merits the **MADE IN GERMANY** mark of excellence, in terms of performance and quality. With the AlphaLUXX, GIFAS has succeeded in developing a competitive LED floodlight that satisfies the highest demands and can also be used in challenging industrial sectors (for example, the food industry).



Surface coating

Industrial lights often have problems with dirt gathering on the surface and the associated reduction in cooling capability. The **PTFE surface coating (coll. Teflon®)** on the AlphaLUXX has a very low friction coefficient. Dust and dirt literally „bead“ off the light. Even harsh acids cannot attack a PTFE coating. Improved thermal conductivity results from the four-times thinner PTFE coating, in comparison with powder coating.

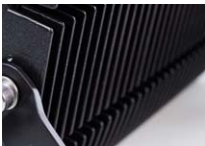

Thermal management

Efficient cooling is crucial to the longevity of the LEDs and ultimately affects the whole lighting system. In order to achieve this on a long-term basis for the AlphaLUXX, several technical components have been used for optimum thermal management. These include a heat sink (housing with cooling fins) made of highly thermo-conductive die-cast aluminium, a PTFE surface with a very thin coating and heat conducting film for optimum connection of the contact areas. We can therefore ensure an **operating temperature range of up to 60° C.**



Quality

The components are selected according to the highest quality standards. High-alloy, corrosion-resistant aluminium housing (230D), stainless steel installation material (V4A), LEDs and electronics from reputable manufacturers (Seoul Semiconductor and Meanwell). Individual testing of every light in accordance with DIN EN 60598-1, certified according to ENEC. The specific coordination of the technical components attains a **service life of 80,000 hours.**



Technology

At up to **149 lumens per watt, the tremendous efficiency** of the AlphaLUXX is currently unique in the market. Also available as a dimmable version.

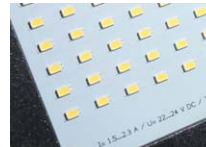

LED

The AlphaLUXX uses exclusively **high-end SMD LEDs** from reputable manufacturers, which are ideal in terms of light quality, lifespan, light color and efficiency. The neutral, white 5000K light and the good color rendering index of over Ra 80, match the maximum human vision in daylight and as a result the best resolution of detail.

AlphaLUXX 25-60



Light intensity distribution at 120°

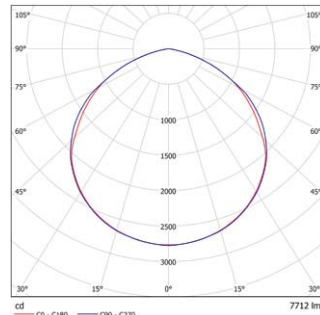

Product features

- Enormous efficiency of up to 149 lumens per watt
- Robust housing made of corrosion-resistant die-cast aluminium (alloy: 230D)
- Dirt-resistant PTFE surface coating, approved for the food industry
- PC-panel 3 mm
- Custom-made U-profile seal surrounding all sides
- Custom-made, durable, heat-conducting film for lasting, reliable dissipation of heat from the LED board
- Low heat generation thanks to the latest LED technology
- Pressure compensation element for extreme temperature fluctuations
- Full luminous flux is available instantly after switching on
- Low energy consumption with high light output
- Maintenance-free
- Wide operating temperature range (up to 60°C)
- No UV/IR radiation
- Vibration-resistant

Technical data

Operating Voltage	100-240 VAC (50/60Hz)
Illuminant	SMD-LEDs
Model	25W / 40W / 60W
System performance	25W / 40W / 60W
Luminous flux	3.544lm / 5.430lm / 7.700lm
System Efficiency	142lm/W / 138lm/W / 130lm/W
Light color	5.000K (4.000K on request)
Beam Angle	120°
CRI (Color reproduction index)	Ra >80
L70/B10	> 80.000h
Type of protection	IP65
Protection class	I
Shock resistance	IK10 (*Version: PC cover)
Dimming	optional 1~10V (DALI with additional module)
Temperature range for operation	25W -30°C to +60°C 40W -30°C to +55°C 60W -30°C to +50°C
Max. surface temperature	+90°C (suitable for use in industrial premises with fire hazards), D rating label
Housing material	Die-cast aluminium, alloy 230D
Housing surface	PTFE-coated (approved for the food industry)
Housing color	black (other colors also available with powder coating)
Cover	3 mm PC clear, optional 3 mm PC satined
Weight	approx. 2,7 kg
Dimensions (LxWxH)	289 x 176 x 85,5 mm
Certification	ENEC, CE, IK10 (suitable for food industry)

Front glass with polycarbonate

EDP No.	Product-ID-No.	Description
800083	ALPHALUXX.25W.230VAC.PC.KLAR	Floodlight 100-240VAC, 25W, IP65, 5.000K, 3.544lm, Cover PC 3 mm, clear
800075	ALPHALUXX.40W.230VAC.PC.KLAR	Floodlight 100-240VAC, 40W, IP65, 5.000K, 5.430lm, Cover PC 3 mm, clear
800084	ALPHALUXX.60W.230VAC.PC.KLAR	Floodlight 100-240VAC, 60W, IP65, 5.000K, 7.700lm, Cover PC 3 mm, clear

Accessories

123867	ALPHALUXX-TEE-TUBE. KABELVERBINDER. 3P:16A.400V.IP688	Cable connector THB.391.A3A, PA66GF, screw terminals 0.5-2.5 mm ² , for cables 7-12 mm Connection assignment 3-pin 2/3/4
--------	---	--

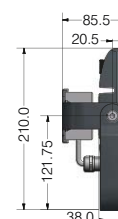
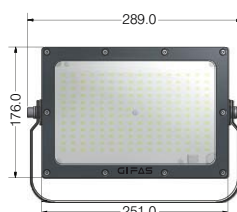

AlphaLUXX 80-120



Light intensity distribution at 120°

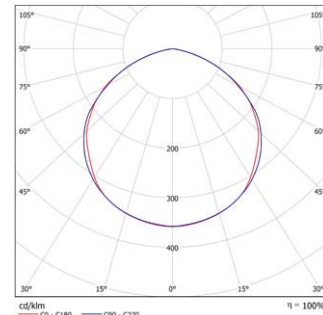

Product features

- Enormous efficiency of up to 149 lumens per watt
- Also available in a dimmable version
- Robust housing made of corrosion-resistant die-cast aluminium (alloy: 230D)
- Dirt-resistant PTFE surface coating, approved for the food industry
- 5 mm toughened glass (ESG), PC panel also available
- Custom-made U-profile seal surrounding all sides
- Custom-made, durable, heat-conducting film for lasting, reliable dissipation of heat from the LED board
- Low heat generation thanks to the latest LED technology
- Pressure compensation element for extreme temperature fluctuations
- Full luminous flux is available instantly after switching on
- Low energy consumption with high light output
- Maintenance-free
- Wide operating temperature range (up to 60°C)
- No UV/IR radiation
- Vibration-resistant

Front glass made of ESG

EDP No.	Product-ID-No.	Description
800049	ALPHALUXX.80W.230VAC.ESG.KLAR	Floodlight 100-277 VAC, 80W, IP65, 5.000K, 12.801lm, BA 120°, 5 mm ESG clear
800048	ALPHALUXX.100W.230VAC.ESG.KLAR	Floodlight 100-277 VAC, 100W, IP65, 5.000K, 16.432lm, BA 120°, 5 mm ESG clear
800043	ALPHALUXX.120W.230VAC.ESG.KLAR	Floodlight 100-277 VAC, 120W IP65, 5.000K, 18.636lm, BA 120°, 5 mm ESG clear
800052	ALPHALUXX.120W.230VAC.ESG.KLAR. Dimmable	Floodlight 100-277 VAC, 120W, IP65, 5.000K, 18.636lm, BA 120°, 1-10V dimmable

Front glass with polycarbonate

800074	ALPHALUXX.80W.230VAC.PC.KLAR	Floodlight 100-277 VAC, 80W, IP65, 5.000K, 12.801lm, BA 120°, Cover PC 5 mm, clear, IK10
800098	ALPHALUXX.100W.230VAC.PC.KLAR	Floodlight 100-277 VAC, 100W, IP65, 5.000K, 16.432lm, BA 120°, Cover PC 5 mm, clear, IK10
800054	ALPHALUXX.120W.230VAC.PC.KLAR	Floodlight 100-277 VAC, 120W, IP65, 5.000K, 18.636lm, BA 120°, Cover PC 5 mm, clear, IK10

Accessories

123867	ALPHALUXX-TEE-TUBE. KABELVERBINDER. 3P.16A.400V.IP688	Cable connector THB.391.A3A, PA66GF, screw terminals 0.5-2.5 mm², for cables 7-12 mm Connection assignment 3-pin 2/3/4
--------	---	---

Technical data

Operating Voltage	100-277 VAC (50/60Hz)
Illuminant	SMD-LEDs
Model	80W / 100W / 120W
System performance	86W / 111W / 128W
Luminous flux	12.801lm / 16.432lm / 18.636lm
System Efficiency	149lm/W / 149lm/W / 146lm/W
Light color	5.000K (4.000K on request)
Beam Angle	120°
CRI (Color reproduction index)	Ra >80
L70/B10	> 80.000h
Type of protection	IP65
Protection class	I
Shock resistance	IK10 (*Version: PC cover)
Dimming	optional 1~10V (DALI with additional module)
Temperature range for operation	80W -30°C to +60°C 100W -30°C to +55°C 120W -30°C to +50°C
Max. surface temperature	+90°C (suitable for use in industrial premises with fire hazards), D rating label
Housing material	Die-cast aluminium, alloy 230D
Housing surface	PTFE-coated (approved for the food industry)
Housing color	black (other colors also available with powder coating)
Cover	5 mm ESG clear or 5 mm PC clear, optional 5 mm ESG satined
Weight	approx. 7,0 kg
Dimensions (LxWxH)	389 x 252 x 106,5 mm
Certification	ENEC, CE, IK10

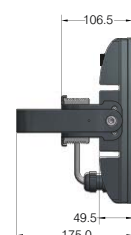

AlphaLUXX 80-120 Ball-proof



Ball-proof according to
DIN VDE 0710-13

AlphaLUXX 80-120 Ball-proof

With the AlphaLUXX ball impact resistant GIFAS offers a robust, safe solution for the lighting of sports facilities.

The AlphaLUXX 80-120 reliably withstands the specific conditions that can affect luminaires in sports hall under ball bombardment, such as handball, indoor football or volleyball, and ensures permanently safe lighting. The stable fixation of the retaining bracket ensures that the spotlight remains reliably in the attached position.

Product features

- Ball-proof design for sports halls according to DIN VDE 0710-13
- Robust housing made of corrosion-resistant die-cast aluminium
- Dirt-repellent PTFE surface coating
- Impact resistant plastic screen (PC)
- Custom-made circumferential U-profile seal
- Low heat generation thanks to state-of-the-art LED technology
- Pressure compensation element for extreme temperature fluctuations
- Full luminous flux immediately after switching on
- Low energy consumption with high luminous efficiency
- Maintenance-free
- Large temperature range (up to 60 °C)
- No UV/IR radiation
- Vibration-resistant

Technical data

Operating Voltage	100-277 VAC (50/60Hz)
Illuminant	SMD-LEDs
Model	80W / 100W / 120W
System performance	86W / 111W / 128W
Luminous flux	12.800lm / 16.500lm / 18.636lm
System Efficiency	149lm/W / 149lm/W / 146lm/W
Light color	5.000K, optional 4.000K
Beam Beam Angle	120°
CRI (Color reproduction index)	Ra >80
L70/B10	> 80.000h
Type of protection	IP66
Protection class	I
Shock resistance	IK10 (*Version: PC cover)
Dimming	optional 1-10V dimming optional DALI interface
Temperature range for operation	80W -30°C to +60°C 100W -30°C to +55°C 120W -30°C to +50°C
Max. surface temperature	+90°C (suitable for use in industrial premises with fire hazards), D rating label
Housing material	Die-cast aluminium, alloy 230D
Housing surface	PTFE-coated
Housing color	black (optional other colors also available)
Cover	5 mm PC clear, optional satined
Weight	approx. 7,0 kg
Dimensions (LxBxH)	389 x 252 x 106,5 mm
Certification	DIN VDE 0710-13, ENEC, CE, IK10

EDP No.	Product-ID-No.	Description
800203	ALPHALUXX.80W.230VAC. PC.KLAR.BALLWURFSICHER	AlphaLUXX Ball-proof, 80W, 5.000K, 12.800lm, PC clear, 230V
800202	ALPHALUXX.100W.230VAC. PC.KLAR.BALLWURFSICHER	AlphaLUXX Ball-proof, 100W, 5.000K, 16.500lm, PC clear, 230V
800201	ALPHALUXX.120W.230VAC. PC.KLAR.BALLWURFSICHER	AlphaLUXX Ball-proof, 120W, 5.000K, 18.636lm, PC clear, 230V



LED Floodlight - AlphaLUXX



AlphaLUXX - lighting of warehouses / storage areas



AlphaLUXX - Facade lighting

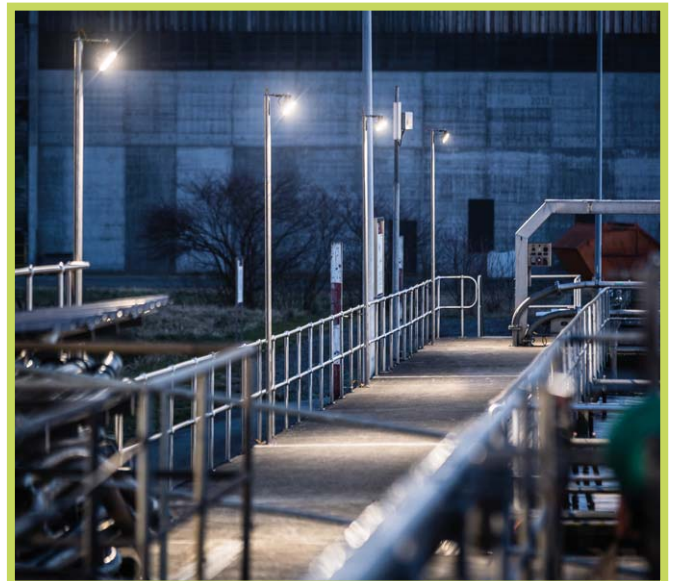

AlphaLUXX - Lighting of a wastewater treatment plant



AlphaLUXX - Lighting in the power plant



AlphaLUXX - Tunnel lighting





**LED Floodlight
PLAZA FlatLED**

PLAZA FlatLED - General / Features



Compact Floodlight – PLAZA FlatLED

Slim design, single - LED technology and the latest, highly efficient driver technology were joined for a new LED light - the PLAZA FlatLED of GIFAS-ELECTRIC. In addition to ease of maintenance, high energy efficiency and high reliability, the PLAZA FlatLED is characterized by its simple design. Available in different capacities and various optics, uniform and planar hall lighting, a wide range of outdoor areas, or to use for lighting a highbay warehouse - all lighting requirements can be solved.



Compact design

By using the latest advanced technology an extremely thin design and a modern and simple appearance can be achieved.



Light Distribution

The light distribution of the PLAZA FlatLED has been designed to achieve uniformity and a homogeneous illumination situation even over large areas. Through the prism glass used not only the light is optimally protected, the glare is reduced.



Single-LED technology

In order to increase the light output and reliability of the lamp, it has many individual LEDs.



Type of protection

To withstand all odds, it was designed for a protection of IP65 / IP66. So you can always be sure that the light meets all your needs.



Fixture

Through the flexible fixture, the lamp can be adjusted to achieve the best illumination.

PLAZA FlatLED FLOOD 16W



Light intensity distribution at 120°

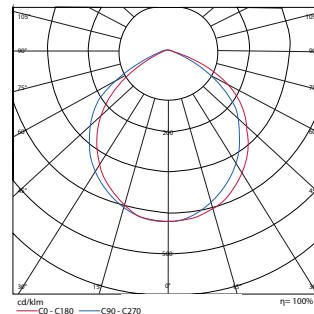

Product features

Flat surface floodlight with symmetrical light characteristic. PLAZA FlatLED FLOOD 16W has a slim design, is powder-coated color black, with 5 m supply line H05RN-F and IP44 safety plug.

- Full luminous flux is available immediately
- Lower power consumption with good luminous efficiency
- Minimal temperature development
- Extremely resistant to switching (> 1 million)
- Maintenance-free
- Operates within a broad temperature range -20°C to +50°C
- No UV/IR-radiation
- Not sensitive to impact and vibrations

Use: Indoor and Outdoor

Billboards, driveways, facades and object lighting, civil protection, schools, public building ...

Appropriate for all locations where a broad area of illumination is required.

Included in the box

- Fixing bracket for ceiling- wall- or floor-mounting

Optional accessories available (see page 30).

Technical data

Operating Voltage	230VAC / 220VDC
LED Power	16W
Illuminant	SMD-LEDs
System Efficiency	138lm/W
Luminous flux	2.200lm
CRI Index	Ra > 80
L80/B50	> 85.000 Std.
Loss of luminous flux	< 10%
LED resistance to switching	> 1 mio
Color temperature	5.700K
MacAdam	3-step
Temperature range for operation	-20°C to +50°C
Max. surface temperature	+90°C (suitable for use in industrial premises with fire hazards), D rating label
Housing material + reflector	aluminium
Housing color	black
Cover	5 mm safety-glass
Type of protection / protection class	IP66 / I
Type of protection plug	IP44
Degree of protection against mechanical	IK08
Weight	1,3 kg
Dimensions H x W x D	205 x 150 x 44 mm

Light color cool white 5.700K		
EDP No.	Product-ID-No.	Watt
840649	PLAZA.FLATLED.FLOOD.16W.CW.230VAC.IP66	16W

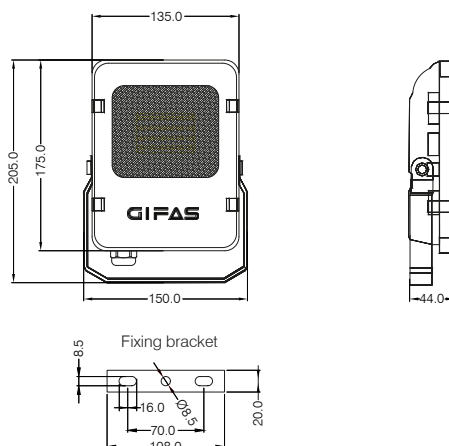

PLAZA FlatLED FLOOD 24W



Light intensity distribution at 120°

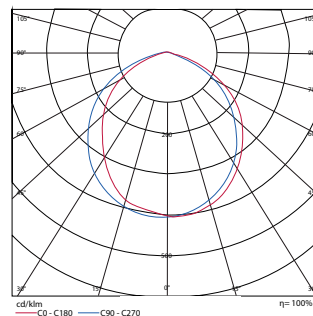

Product features

Flat surface floodlight with symmetrical light characteristic. Plaza FlatLED FLOOD 24W has a slim design, is powder-coated color black, with 5 m supply line H07RN-F and IP44 safety plug.

- Full luminous flux is available immediately
- Lower power consumption with good luminous efficiency
- Minimal temperature development
- Extremely resistant to switching (>1 million)
- Maintenance-free
- Operates within a broad temperature range -20°C to +50°C
- No UV/IR-radiation
- Not sensitive to impact and vibrations

Use: Indoor and Outdoor

Billboards, driveways, facades and object lighting, civil protection, schools, public building ...

Appropriate for all locations where a broad area of illumination is required.

Included in the box

- Fixing bracket for ceiling- wall- or floor-mounting

Optional accessories available (see page 30).

Technical data

Operating Voltage	230VAC / 220VDC
LED Power	24W
Illuminant	SMD-LEDs
System Efficiency	142lm/W
Luminous flux	3.400lm
CRI Index	Ra > 80
L80/B50	> 85.000 Std.
Loss of luminous flux	< 10%
LED resistance to switching	> 1 mio
Color temperature	5.700K
MacAdam	3-step
Temperature range for operation	-20°C to +50°C
Max. surface temperature	+90°C (suitable for use in industrial premises with fire hazards), D rating label
Housing material + reflector	aluminium
Housing color	black
Cover	5 mm safety-glass
Type of protection / protection class	IP66 / I
Type of protection plug	IP44
Degree of protection against mechanical	IK08
Weight	2,3 kg
Dimensions H x W x D	251 x 200 x 45 mm

Light color cool white 5.700K

EDP No.	Product-ID-No.	Watt
800039	PLAZA.FLATLED.FLOOD.24W.CW.230VAC.IP66	24W

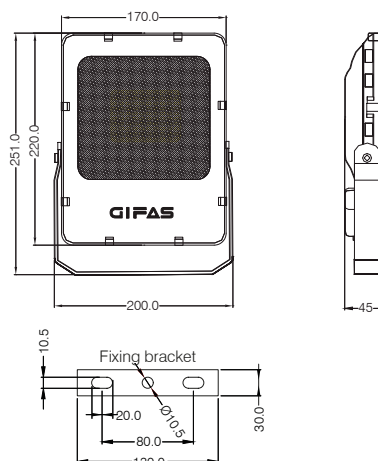

PLAZA FlatLED FLOOD 48W



Light intensity distribution at 120°

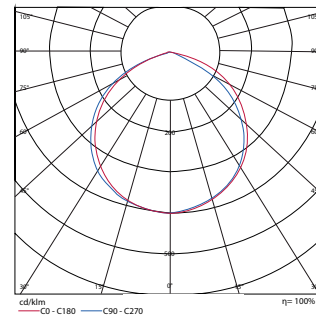

Product features

Flat surface floodlight with symmetrical light characteristic. Plaza FlatLED FLOOD 48W has a slim design, is powder-coated color black, with 5 m supply line H07RN-F and IP44 safety plug.

- Full luminous flux is available immediately
- Lower power consumption with good luminous efficiency
- Minimal temperature development
- Extremely resistant to switching (>1 million)
- Maintenance-free
- Operates within a broad temperature range -20°C to +50°C
- No UV/IR-radiation
- Not sensitive to impact and vibrations

Use: Indoor and Outdoor

Billboards, driveways, facades and object lighting, civil protection, schools, public building ...

Appropriate for all locations where a broad area of illumination is required.

Included in the box

- Fixing bracket for ceiling- wall- or floor-mounting

Optional accessories available (see page 30).

Technical data

Operating Voltage	230VAC / 220VDC
LED Power	48W
Illuminant	SMD-LEDs
System Efficiency	150lm/W
Luminous flux	7.500lm
CRI Index	Ra>80
L80/B50	>85.000 Std.
Loss of luminous flux	<10%
LED resistance to switching	>1 mio
Color temperature	5.700K
MacAdam	3-step
Temperature range for operation	-20°C to +50°C
Max. surface temperature	+90°C (suitable for use in industrial premises with fire hazards), D rating label
Housing material + reflector	aluminium
Housing color	black
Cover	5 mm safety-glass
Type of protection / protection class	IP66 / I
Type of protection plug	IP44
Degree of protection against mechanical	IK08
Weight	4,1 kg
Dimensions H x W x D	330 x 243 x 58 mm

Light color cool white 5.700K

EDP No.	Product-ID-No.	Watt
800040	PLAZA.FLATLED.FLOOD.48W.CW.230VAC.IP66	48W

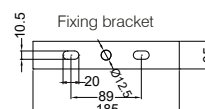
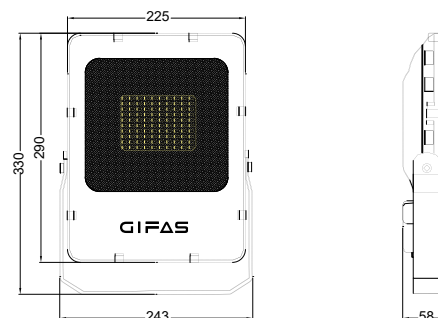

PLAZA FlatLED FLOOD 72W



Light intensity distribution at 120°

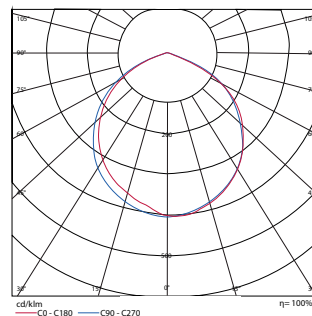

Product features

Flat surface floodlight with symmetrical light characteristic. Plaza FlatLED FLOOD 72W has a slim design, is powder-coated color black, with 5 m supply line H07RN-F and IP44 safety plug.

- Full luminous flux is available immediately
- Lower power consumption with good luminous efficiency
- Minimal temperature development
- Extremely resistant to switching (>1 million)
- Maintenance-free
- Operates within a broad temperature range -20°C to +50°C
- No UV/IR-radiation
- Not sensitive to impact and vibrations

Use: Indoor and Outdoor

Billboards, driveways, facades and object lighting, civil protection, schools, public building ...

Appropriate for all locations where a broad area of illumination is required.

Included in the box

- Fixing bracket for ceiling- wall- or floor-mounting

Optional accessories available (see page 30).

Technical data

Operating Voltage	230VAC / 220VDC
LED Power	72W
Illuminant	SMD-LEDs
System Efficiency	150lm/W
Luminous flux	10.180lm
CRI Index	Ra > 80
L80/B50	> 85.000 Std.
Loss of luminous flux	< 10%
LED resistance to switching	> 1 mio
Color temperature	5.700K
MacAdam	3-step
Temperature range for operation	-20°C to +50°C
Max. surface temperature	+90°C (suitable for use in industrial premises with fire hazards), D rating label
Housing material + reflector	aluminium
Housing color	black
Cover	5 mm safety-glass
Type of protection / protection class	IP66 / I
Type of protection plug	IP44
Degree of protection against mechanical	IK08
Weight	5,5 kg
Dimensions H x W x D	372 x 265 x 80 mm

Light color cool white 5.700K

EDP No.	Product-ID-No.	Watt
800041	PLAZA.FLATLED.FLOOD.72W.CW.230VAC.IP66	72W

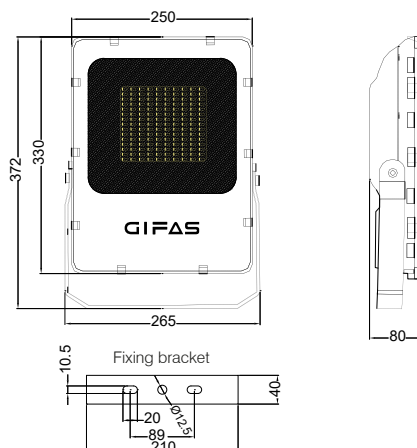

PLAZA FlatLED FLOOD 150W



Light intensity distribution at 120°

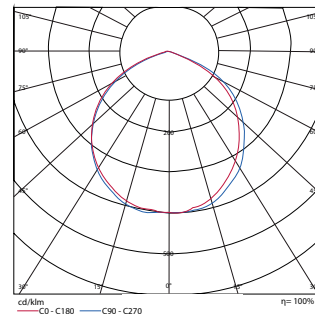

Product features

Flat surface floodlight with symmetrical light characteristic. Plaza FlatLED FLOOD 150W has a slim design, is powder-coated color black, with 5 m supply line H07RN-F and IP44 safety plug.

- Full luminous flux is available immediately
- Lower power consumption with good luminous efficiency
- Minimal temperature development
- Extremely resistant to switching (>1 million)
- Maintenance-free
- Operates within a broad temperature range -20°C to +50°C
- No UV/IR-radiation
- Not sensitive to impact and vibrations

Use: Indoor and Outdoor

Billboards, driveways, facades and object lighting, civil protection, schools, public building ...

Appropriate for all locations where a broad area of illumination is required.

Included in the box

- Fixing bracket for ceiling- wall- or floor-mounting

Optional accessories available (see page 30).

Technical data

Operating Voltage	230VAC / 220VDC
LED Power	150W
Illuminant	SMD-LEDs
System Efficiency	150lm/W
Luminous flux	21.220lm
CRI Index	Ra > 80
L80/B50	> 85.000 Std.
Loss of luminous flux	< 10%
LED resistance to switching	> 1 mio
Color temperature	5.700K
MacAdam	3-step
Temperature range for operation	-20°C to +50°C
Max. surface temperature	+90°C (suitable for use in industrial premises with fire hazards), D rating label
Housing material + reflector	aluminium
Housing color	black
Cover	5 mm safety-glass
Type of protection / protection class	IP66 / I
Type of protection plug	IP44
Degree of protection against mechanical	IK08
Weight	9,0 kg
Dimensions H x W x D	450 x 355 x 95 mm

Light color cool white 5.700K		
EDP No.	Product-ID-No.	Watt
840359	PLAZA.FLATLED.FLOOD.150W.CW.230VAC.IP66	150W

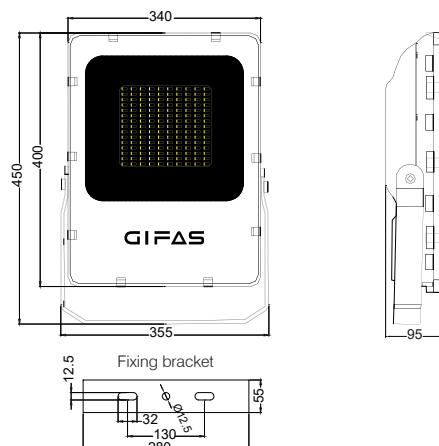

Wall bracket for PLAZA FlatLED (16W - 150W)

LED Floodlight - PLAZA FlatLED



Allows the lamp to be installed at a distance of 80cm from walls and floors. In accordance to the light the wall bracket is also kept in black.

EDP No.	Product-ID-No.
119598	PLAZA.FLATLED.12-150W.WANDAUSLEGER.80CM



PLAZA FlatLED - Osvetlenie na mostoch / prechodoch

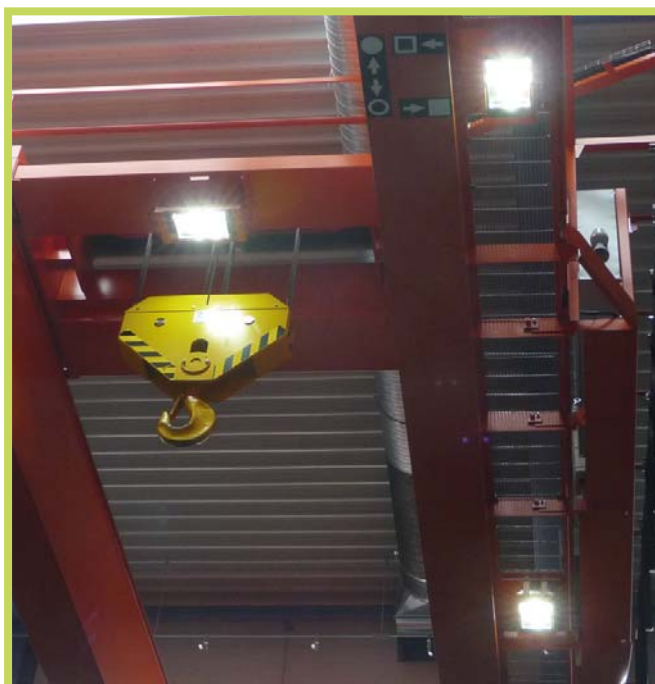
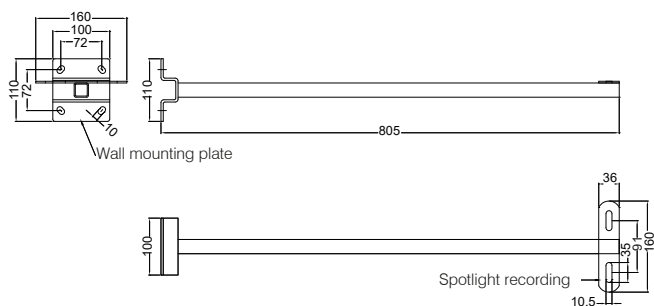

PLAZA - Crane lighting

LED Floodlight - PLAZA FlatLED



PLAZA FlatLED - Parking lot lighting



PLAZA - Area lighting in halls



PLAZA - Lighting in waste incineration plant



PLAZA FlatLED - Lighting in a transformer station



PLAZA - Lighting in foundry

CONTACT US



GIFAS
ELECTRIC

GIFAS ELECTRIC
Gesellschaft m.b.H.
Strass 2
5301 Eugendorf
AUSTRIA

www.gifas.at
✉ verkauf@gifas.at
☎ +43 6225/7191-0
📠 +43 6225/7191-561
☎ +49 8654/404-2000