

SYSTEMATIC QUALITY

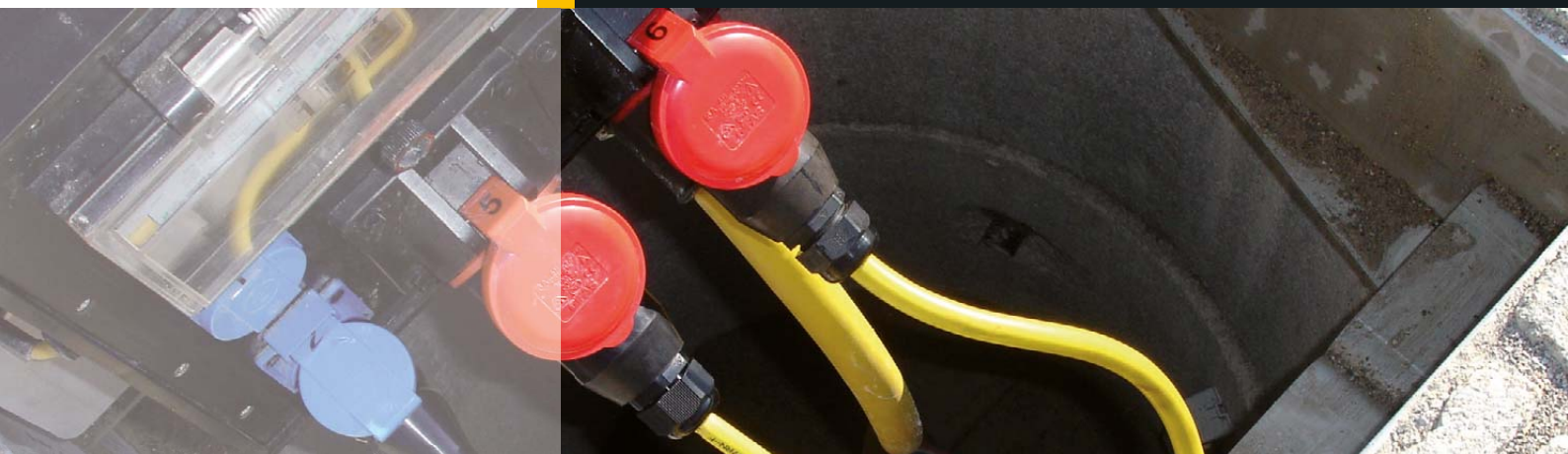

Plug-in connectors



Schuko connectors Solid rubber CEE-socket

Page 4 - 6

Solid rubber Schuko connectors



Page 4

Schuko connectors



Page 4

Schuko socket connectors – waterproof



Page 5

Solid rubber CEE connectors



Page 5

Solid rubber CEE built-in sockets and wall sockets



Page 6

Solid rubber CEE low-voltage plug connections

Page 7

CEE-low-voltage connectors



Page 7

Solid rubber-reducers

Page 8

Solid rubber reducers



Page 8

Plastic CEE plug connections built-in sockets

Page 9 - 10

CEE-plug and couplings



Page 9

Built-in sockets



Page 10

Plastic CEE appliance plug

Page 11

CEE-appliance plug



Page 11

Special Connectors
Industrial plug connections

Page 14 - 19

Single pole high current connector Decontactors and plug connections



Page 14 - 17

Page 18 - 19

Dimensions table

Page 12 - 13

Dimensions table

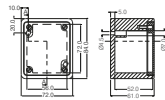

Page 12 - 13

Solid rubber schuko connectors with nickel-plated pins



Solid rubber schuko plug connections, IP44				
EDP No.	EDP No. F&B	Product-ID-No.	Ampere	Volt
10735		111	16A	230V

Industrial design, for cables up to 3G2.5



Solid rubber schuko coupling, IP44				
EDP No.	EDP No. F&B	Product-ID-No.	Ampere	Volt
10930	120253	211	16A	230V

Industrial design, for cables up to 3G2.5



Solid rubber triple schuko coupling, IP44				
EDP No.	EDP No. F&B	Product-ID-No.	Ampere	Volt
11288	84969	313	16A	230V

Industrial design, for cables up to 3G2.5

Schuko socket connectors – waterproof with nickel-plated pins



Schuko plug, IP68				
EDP No.	EDP No. F&B	Product-ID-No.	Ampere	Volt
48037	120224	111.BLAU.IP68	16A	230V



Schuko coupling, IP68				
EDP No.	EDP No. F&B	Product-ID-No.	Ampere	Volt
48317	125978	211.BLAU.IP68	16A	230V



Built-in schuko socket, IP68				
EDP No.	EDP No. F&B	Product-ID-No.	Ampere	Volt
43156	120223	309.BLAU.IP68*	16A	230V

Schuko connectors with nickel-plated pins



Built-in schuko socket, IP54				
EDP No.	EDP No. F&B	Product-ID-No.	Ampere	Volt
11212	38427	309*	16A	230V

Made of break-proof thermoplast with spring cover with additional gasket.



Solid rubber structure schuko socket, IP65				
EDP No.	EDP No. F&B	Product-ID-No.	Ampere	Volt
70682	125965	1010.309.IP68.1M20*	16A	230V

Black solid rubber cabinet series 1010, 1/cable gland M20. Large space for connecting



Schuko socket structure, IP54				
EDP No.	EDP No. F&B	Product-ID-No.	Ampere	Volt
13799	85054	308*	16A	230V

Solid rubber cabinet series 308, gray RAL 7035, 1/cable gland M16.



Solid rubber wall schuko triple socket, IP65				
EDP No.	EDP No. F&B	Product-ID-No.	Ampere	Volt
72396	125967	1616.3X309.BLAU.IP68.3EKL.1M20	16A	230V

Black solid rubber cabinet series 1616, 1/cable gland M20.



Schuko structure, IP54				
EDP No.	EDP No. F&B	Product-ID-No.	Ampere	Volt
25077	85055	21309.PA*	16A	230V

Black solid rubber cabinet series 2100 1/ cable gland M20. Large space for plug connections and sockets in the sense of CEE 16A 2P+E 230V at any time.

* For dimensions, see page 13.

Solid rubber CEE connectors
with nickel-plated pins

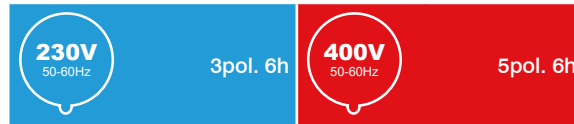

Solid rubber CEE-plug						
Ampere	Number of poles	EDP No.	Product-ID-No.	EDP No.	Product-ID-No.	Protection
16A	2P + E	10870	201636			IP44
16A	3P + N + E			11090	301656	IP44



Solid rubber CEE-coupling						
Ampere	Number of poles	EDP No.	Product-ID-No.	EDP No.	Product-ID-No.	Protection
16A	2P + E	10878	201637			IP44
16A	3P + N + E			11098	301657	IP44



Solid rubber CEE-plug						
Ampere	Number of poles	EDP No.	Product-ID-No.	EDP No.	Product-ID-No.	Protection
32A	3P + N + E			11141	303256	IP44



Solid rubber CEE-coupling						
Ampere	Number of poles	EDP No.	Product-ID-No.	EDP No.	Product-ID-No.	Protection
32A	3P + N + E			11151	303257	IP44



Solid rubber CEE-plug						
Ampere	Number of poles	EDP No.	Product-ID-No.	EDP No.	Product-ID-No.	Protection
63A	3P + N + E			11194	306356	IP67

Solid rubber CEE built-in sockets and wall sockets with nickel-plated pins

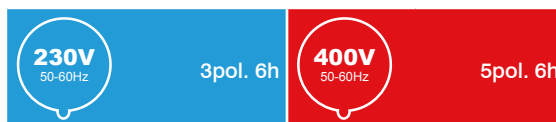

Solid rubber CEE built-in sockets						
Ampere	Number of poles	EDP No.	Product-ID-No.	EDP No.	Product-ID-No.	Protection
16A	2P + E	10884	201639*			IP44
16A	3P + N + E			11106	301659*	IP44
16A	3P + N + E			11108	301659.S*	IP44



Solid rubber CEE built-in sockets						
Ampere	Number of poles	EDP No.	Product-ID-No.	EDP No.	Product-ID-No.	Protection
32A	3P + N + E			11155	303259*	IP44



Solid rubber CEE wall sockets						
Ampere	Number of poles	EDP No.	Product-ID-No.	EDP No.	Product-ID-No.	Protection
16A	2P + E	26078	21201639*			IP44
16A	3P + N + E			25243	26301659*	IP44



Solid rubber CEE wall sockets						
Ampere	Number of poles	EDP No.	Product-ID-No.	EDP No.	Product-ID-No.	Protection
32A	3P + N + E			25321	25303259*	IP44

* For dimensions, see pages 12-13.

Solid rubber CEE low-voltage connectors with nickel-plated pins

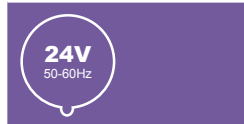

Solid rubber CEE plug						
Ampere	Number of poles	EDP No.	Product-ID-No.	EDP No.	Product-ID-No.	Protection
16A	2P	10949	241626	11515	421626	IP44



Solid rubber CEE coupling						
Ampere	Number of poles	EDP No.	Product-ID-No.	EDP No.	Product-ID-No.	Protection
16A	2P	10952	241627	11516	421627	IP44



Solid rubber CEE built-in sockets						
Ampere	Number of poles	EDP No.	Product-ID-No.	EDP No.	Product-ID-No.	Protection
16A	2P	10956	241629*	11519	421629*	IP44



Solid rubber CEE wall sockets						
Ampere	Number of poles	EDP No.	Product-ID-No.	EDP No.	Product-ID-No.	Protection
16A	2P	25141	21241629*	26135	21421629*	IP44

* For dimensions, see pages 12-13.

Solid rubber reducers



The GIFAS reducers are manufactured according to the ÖVE standard. They offer the user the highest levels of safety by installing fuses and earth leakage circuit breakers.

For simultaneous all-pole disconnection and reconnection, safety is guaranteed.

Regulations for reducers and industrial connectors can be found in ÖVE-EN 50250.

Equipment that protects against overcharge must be installed in all places where the permissible permanent current is reduced, provided that the protective equipment primarily installed cannot provide such protection.

One-piece reducers with industrial plug connections are not permitted. There must be a flexible cord between the plug and the socket with a minimum length of 800 mm in Austria and, and about 1 m in Germany.

Solid rubber reducers					
EDP No.	EDP No. F&B	Product-ID-No.	Entry	Outlet	Fusing
48378	85056	21161.PA.2M.GG	2 m Proflexx cable 3x2.5 mm ² with solid rubber CEE plug 5x16A 400V	1/Schuko socket 16A 230V	
48379	116546	213201.PA.2M.GG	2 m Proflexx cable 3x4.0 mm ² with solid rubber CEE plug 5x32A 400V	1/Schuko socket 16A 230V	glass tube fuse 16A

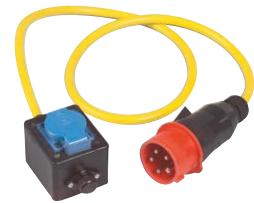

W x H x D: 72 x 84 x 61 mm

Solid rubber reducers					
EDP No.	EDP No. F&B	Product-ID-No.	Entry	Outlet	Fusing
77498		723219.2M.GG	2 m Proflexx cable 5x4.0 mm ² with Solid rubber CEE plug 5x32A 400V	1/Solid rubber CEE socket 5x16A 400V	1/LS-switch 3pol. 16A
77499		726319.2M.GG	2 m Proflexx cable 5x16.0 mm ² with Solid rubber CEE plug 5x63A 400V	1/Solid rubber CEE socket 5x16A 400V	1/LS-switch 3pol. 16A
77497		726339.2M.GG	2 m Proflexx cable 5x16.0 mm ² with Solid rubber CEE plug 5x63A 400V	1/Solid rubber CEE socket 5x32A 400V	1/LS-switch 3pol. 32A



W x H x D: 160 x 280 x 133 mm
The safety material is installed under a shock-resistant transparent cover; in this position, it is splash-proof

Model the optimum solution for your requirements with our engineers.

Series 2100

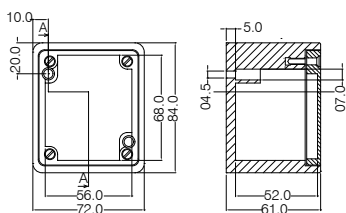

Series 7200

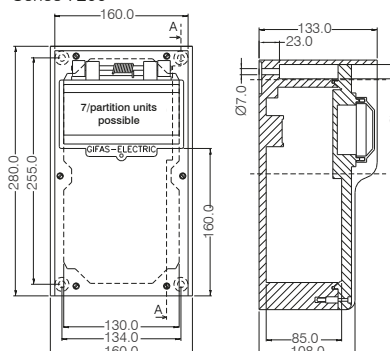

03/2021/1.0

Plastic CEE-connectors with nickel-plated pins



CEE plug						
Ampere	Number of poles	EDP No.	Product-ID-No.	EDP No.	Product-ID-No.	Protection
16A	2P + E	107521	201636.HG			IP44
16A	3P + N + E			107522	301656.HG	IP44
32A	3P + N + E			107524	303256.HG	IP44
CEE phase inverters						
Ampere	Number of poles	EDP No.	Product-ID-No.	EDP No.	Product-ID-No.	Protection
16A	3P + N + E			61558	3016562.HP	IP44
32A	3P + N + E			92649	3032562.HP	IP44
CEE coupling						
Ampere	Number of poles	EDP No.	Product-ID-No.	EDP No.	Product-ID-No.	Protection
16A	2P + E	107564	201637.HG			IP44
16A	3P + N + E			107565	301657.HG	IP44
32A	3P + N + E			18853	303257.HP	IP44



CEE plug						
Ampere	Number of poles	EDP No.	Product-ID-No.	EDP No.	Product-ID-No.	Protection
16A	2P + E	107527	201636.WD.HG			IP67
16A	3P + N + E			107528	301656.WD.HG	IP67
32A	3P + N + E			67976	303256.WD.HP	IP67
CEE phase inverters						
Ampere	Number of poles	EDP No.	Product-ID-No.	EDP No.	Product-ID-No.	Protection
16A	3P + N + E			107530	3016562.WD.HG	IP67
32A	3P + N + E			107531	3032562.WD.HG	IP67
CEE coupling						
Ampere	Number of poles	EDP No.	Product-ID-No.	EDP No.	Product-ID-No.	Protection
16A	2P + E	107665	201637.WD.HG			IP67
16A	3P + N + E			107666	301657.WD.HG	IP67
32A	3P + N + E			107667	303257.WD.HG	IP67



CEE plug						
Ampere	Number of poles	EDP No.	Product-ID-No.	EDP No.	Product-ID-No.	Protection
63A	3P + N + E			107532	306356.WD.HG	IP67
CEE coupling						
Ampere	Number of poles	EDP No.	Product-ID-No.	EDP No.	Product-ID-No.	Protection
63A	3P + N + E			107712	306357.WD.HG	IP67

Alternative model are available upon request.

Plastic CEE built-in sockets with nickel-plated pins

230V 50-60Hz	3pol. 6h	400V 50-60Hz	4pol. 6h 5pol. 6h
------------------------	----------	------------------------	----------------------



CEE built-in sockets, diagonal						
Ampere	Number of poles	EDP No.	Product-ID-No.	EDP No.	Product-ID-No.	Protection
16A	2P + E	107713	201639.HG*			IP44
16A	3P + N + E			107714	301659.HG*	IP44
32A	3P + N + E			107715	303259.HG*	IP44



CEE built-in sockets, diagonal						
Ampere	Number of poles	EDP No.	Product-ID-No.	EDP No.	Product-ID-No.	Protection
16A	2P + E	107716	201639.WD.HG*			IP67
16A	3P + N + E			107717	301659.WD.HG*	IP67
32A	3P + N + E			107718	303259.WD.HG*	IP67



CEE built-in sockets, straight						
Ampere	Number of poles	EDP No.	Product-ID-No.	EDP No.	Product-ID-No.	Protection
16A	2P + E	107720	201639.G.HG*			IP44
16A	3P + N + E			107721	301659.G.HG*	IP44
32A	3P + N + E			107722	303259.G.HG*	IP44



CEE built-in sockets, straight						
Ampere	Number of poles	EDP No.	Product-ID-No.	EDP No.	Product-ID-No.	Protection
16A	2P + E	107723	201639.G.WD.HG*			IP67
16A	3P + N + E			107724	301659.G.WD.HG*	IP67
32A	3P + N + E			107725	303259.G.WD.HG*	IP67

CEE-built-in sockets and wall sockets with nickel-plated pins



CEE built-in sockets						
Ampere	Number of poles	EDP No.	Product-ID-No.	EDP No.	Product-ID-No.	Protection
63A	3P + E			11192	306349*	IP67
63A	3P + N + E			11200	306359*	IP67



Wall sockets with solid rubber cabinet						
Ampere	Number of poles	EDP No.	Product-ID-No.	EDP No.	Product-ID-No.	Protection
63A	3P + E			47616	7250.306349.EKL.1M32*	IP65
63A	3P + N + E			46328	7250.306359.5HKL16.1M32*	IP65

*For dimensions, see pages 12-13

Plastic CEE connector
with nickel-plated pins

230V 50-60Hz	3pol. 6h	400V 50-60Hz	4pol. 6h 5pol. 6h
------------------------	----------	------------------------	----------------------



CEE connector						
Ampere	No. of poles	EDP No.	Product-ID-No.	EDP No.	Product-ID-No.	Protection
16A	3P + N + E			86228	3016556.HP*	IP44
32A	3P + N + E			120595	3032556.HP*	IP44



CEE connector						
Ampere	No. of poles	EDP No.	Product-ID-No.	EDP No.	Product-ID-No.	Protection
16A	2P + E	46771	2016386.HY*			IP44
16A	3P + N + E			11103	3016586.HM*	IP44
32A	3P + N + E			11154	3032586.HM*	IP44



CEE connector						
Ampere	No. of poles	EDP No.	Product-ID-No.	EDP No.	Product-ID-No.	Protection
16A	2P + E	10891	2016396.HP*			IP44
16A	3P + N + E			11118	3016596*	IP44
32A	2P + E	10908	2032396.HP*			IP44
32A	3P + E			11138	3032496*	IP44
32A	3P + N + E			11166	3032596*	IP44
63A	3P + E			11193	3063496.HPGERADE*	IP67
63A	3P + N + E			11207	3063596.HPGERADE*	IP67



* For dimensions, see pages 12-13.

Dimension table – CEE built-in sockets and appliance inlets

Solid rubber CEE built-in sockets

Ampere	Volt	Number of poles	A	B	C	D	E	F	G	H
16A	24-42V	2P	75	64	80	60	52	5.5	60	83
16A	230V	3P	75	64	87	60	52	5.5	60	83
16A	400V	5P	100	100	103	85	77	5.5	60	97
16A	400V	5P*	100	82	103	85	59	5.5	60	97
32A	400V	5P	100	100	121	85	77	5.5	70	107

*narrow flange design

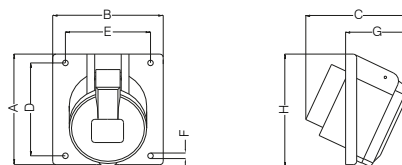

Plastic CEE built-in sockets, diagonal

Ampere	Volt	Number of poles	A	B	C	D	E	F	G	H	Protection
16A	230V	3P	73,5	64	95	60	52	5.3	52	79	IP44
16A	400V	5P	100	92	100	85	77	5.3	56	100	IP44
32A	400V	5P	100	92	115	85	77	5.3	60	106	IP44
16A	230V	3P	73,5	64	102	60	52	5.3	61	80	IP67
16A	400V	5P	100	92	109	85	77	5.3	66	105	IP67
32A	400V	5P	100	92	122	85	77	5.3	70	110	IP67
63A	400V	4P	112	100	144	88	80	7	80	119	IP67
63A	400V	5P	112	100	144	88	80	7	80	119	IP67

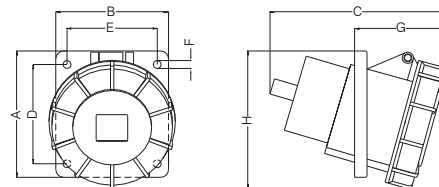

Plastic CEE built-in sockets, straight

Ampere	Volt	Number of poles	A	B	C	D	E	F	G	H	Protection
16A	230V	3P	75	75	88	60	60	5.3	54	80	IP44
16A	400V	5P	75	75	88	60	60	5.3	54	90	IP44
32A	400V	5P	85	75	102	60	60	5.3	64	103	IP44
16A	230V	3P	75	75	96	60	60	5.3	62	82	IP67
16A	400V	5P	75	75	96	60	60	5.3	62	96	IP67
32A	400V	5P	85	75	112	60	60	5.3	74	110	IP67

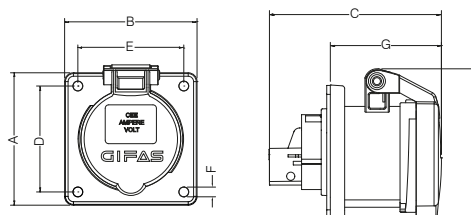

CEE built-in sockets

Ampere	Volt	Number of poles	A	B	C	D	E	F	G	H
16A	230V	3P	70	70	66	56	56	5,0	41	43
16A	400V	5P	70	70	68	56	56	5,0	42	55
32A	230V	3P	70	70	80	56	56	5,0	50	55
32A	400V	4P	70	70	80	56	56	5,0	50	55
32A	400V	5P	70	70	80	56	56	5,0	50	55
63A	400V	4P/5P	100	100	117	80	80	7,0	109	77

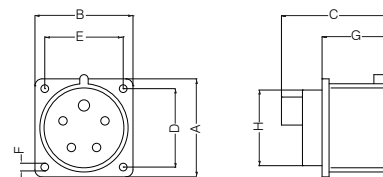

CEE-angle-built-in sockets

Ampere	Volt	Number of poles	A	B	C	D	E	F	G
16A	400V	5P	90	100	77	85	153	5,0	98
32A	400V	5P	90	100	77	85	164	5,0	103

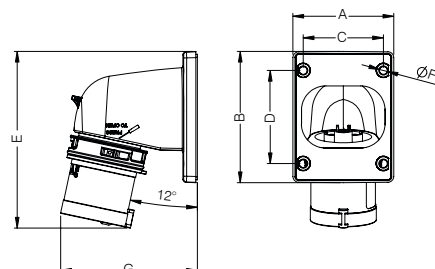

CEE Wall plug

Ampere	Volt	Number of poles	A	B	C	D	E	F	G
16A	230V	3P	100	80	106	50	67	5	139
16A	400V	4P/5P	100	75	108	61	59	5	134
32A	400V	4P/5P	128	83	132	75	68	5	175

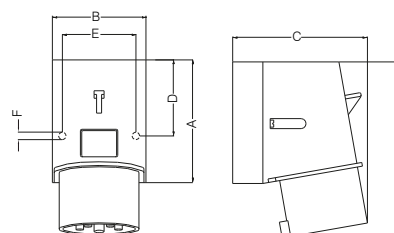

Dimensions table / Dimensions

Series 2100

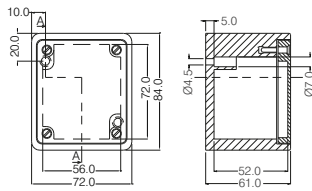

Series 2500, 2600

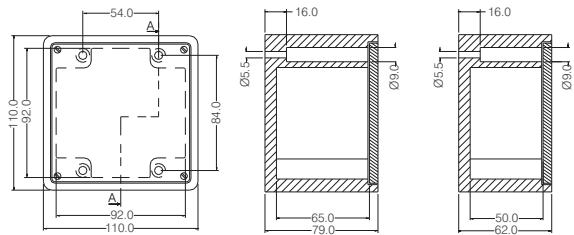

Series 1010

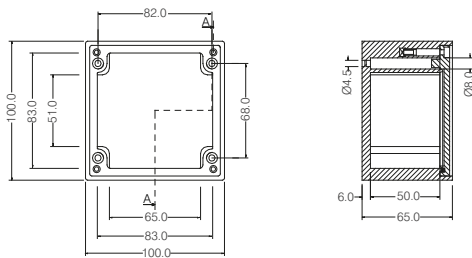

Series 1616

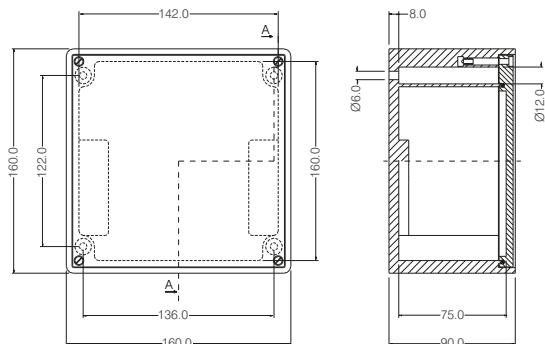

Series 7250

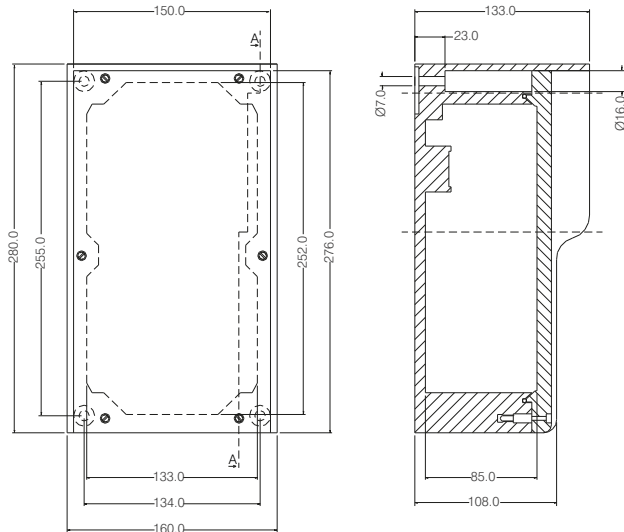

Series 308

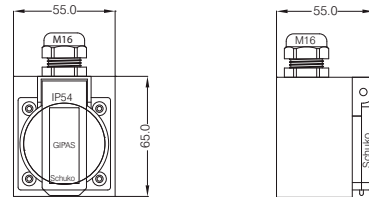

Series 309

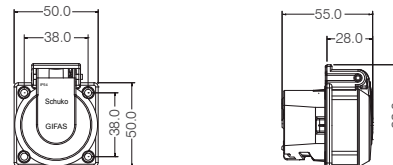

Series 309 IP68

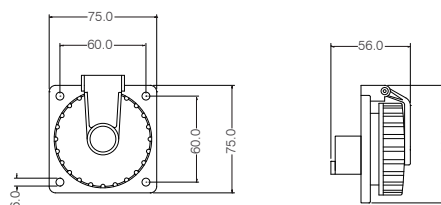

Single pole high current connector - Powersafe

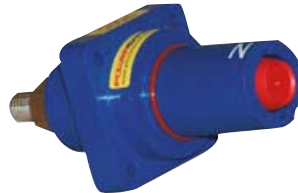

Special contact design

Due to recent developments in the technology of spring blade pins, the electrical characteristics of the connector are undergoing significant improvement:

- Low contact resistance
- Minimal voltage drop
- High short-circuit currents are possible
- Compact design
- Self-cleaning pins
- Lower insertion force when creating the connection
- High power transfer frequency
- High number of mating cycles
- Double-screw terminals for connection to 150 mm² (max. continuous power of 500A.)
- Crimp-clamping for cables up to 300 mm² (max. continuous power 800A)
- In compliance with EN 60529, Powersafe fulfils the requirements for protection class IP67 when plugged in.

Technical data

Number of pins	1
Maximum continuous current	500A - 800A
Surge current resistance	75kA
Short-circuit strength	35.5kA
Connection area	25 mm ² - 300 mm ²
Connection terminals	plug/coupling: to 150 mm ² Screw connection to 300 mm ² crimping connection appliance inlet / socket: bolt M12
Plug-in system	bayonet catch
Rated voltage	1000VAC
Maximum rated voltage to earth	2KVAC/3KVDC
Min. breakdown voltage	9.5KVDC/AC Peak
Insulation resistance	> 5MΩ@500VDC
Protection	IP67
Contact protection for conductive parts	IP2X
Flame-resistance	UL94-VO
Mating cycles	> 500
Housing Material	Thermoplast, high-temperature-resistant
Pin Quality	silvered

Advantages

- Increased surge current strength
- High resistance to short-circuiting
- Increased international protection type
- Simple plug-in system - reduced insertion force required
- Optimum cable relief
- Very high level of impact strength
- Use of special, heat-resistant materials
- Rubber handle for easy, non-slip insertion of the connections
- RoHS-compliant

Technical information

- Distinctively color-coded
- Mechanically coded in order to prevent confusion
- Lock to prevent accidental disconnection under load
- Increased impact-resistant cabinet
- Integrated cable relief
- Metric cable glands in accordance with EN standards with increased clamping range

Applications

Typical areas of application for the Powersafe connectors are lighting distributors, network connection boxes on-stage, generators, AC motors, etc.

These connections, specially designed for the high current range, are, for example, perfect for use in industrial firms, for outdoor concerts, sporting events, and television broadcasts. The improved resistance to impact and increased protection class also allow use in heavy industry, in mining, on large construction sites or in the military.

Detailed information provided upon request.

03/2021/1.0

Single pole high current connector - Powersafe



Plug and coupling dimensions

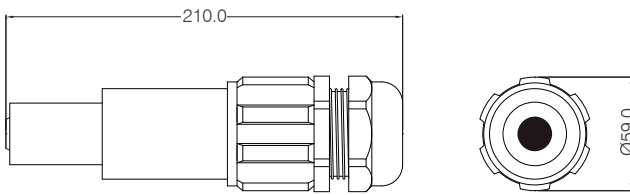

Plug dimensions in mm

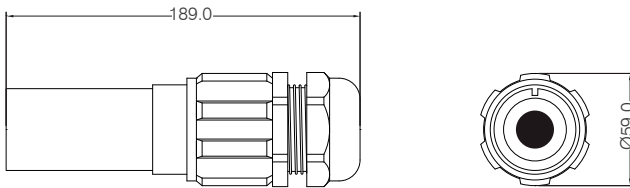

Coupling dimensions in mm

Built-in plug and built-in sockets Dimensions

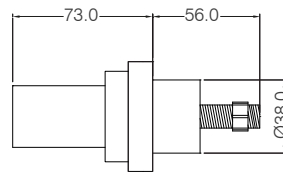

Built-in plug dimensions in mm

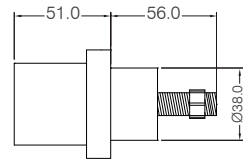
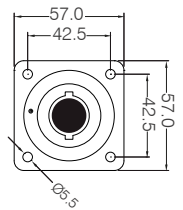

Built-in socket dimensions in mm

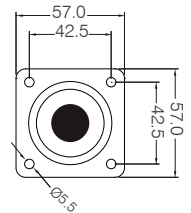

Discharger Powersafe Box



EDP No.	Product-ID-No.	Description
109523	PS.POWERBOX.SOCKET.PS5-E-108GIF.800A.240QMM. MS.UT.M	Powersafe box, panel source box 800A, 108 mm front panel, including MS Connector, incl. unlocking tool
109524	PS.POWERBOX.PLUG.PD5-E-108GIF.800A.240QMM.MS.UT.M	Powersafe box, panel drain box 800A, 108 mm front panel, including MS Connector, incl. unlocking tool

Single pole high current connector - Powersafe

Socket

EDP No.	Product-ID-No.	Description
93282	POWERSAFE.STECKDOSE.L1.BR.500A.M12	Powersafe socket L1 BROWN 500A
93283	POWERSAFE.STECKDOSE.L2.SW.500A.M12	Powersafe socket L2 BLACK 500A
93284	POWERSAFE.STECKDOSE.L3.GR.500A.M12	Powersafe socket L3 GREY 500A
93285	POWERSAFE.STECKDOSE.N.BL.500A.M12	Powersafe socket N BLUE 500A
93286	POWERSAFE.STECKDOSE.PE.GN.500A.M12	Powersafe socket PE GREEN 500A

Protection cap socket

EDP No.	Product-ID-No.	Description
93287	POWERSAFE.STECKDOSE.SCHUTZKAPPE.L1	Powersafe Protection cap for socket
93288	POWERSAFE.STECKDOSE.SCHUTZKAPPE.L2	Powersafe Protection cap for socket
93289	POWERSAFE.STECKDOSE.SCHUTZKAPPE.L3	Powersafe Protection cap for socket
93290	POWERSAFE.STECKDOSE.SCHUTZKAPPE.N	Powersafe Protection cap for socket
93291	POWERSAFE.STECKDOSE.SCHUTZKAPPE.PE	Powersafe Protection cap for socket

Appliance inlet

EDP No.	Product-ID-No.	Description
93292	POWERSAFE.GERÄTESTECKER.L1.BR.500A.M12	Powersafe connector L1 BROWN 500A
93293	POWERSAFE.GERÄTESTECKER.L2.SW.500A.M12	Powersafe connector L2 BLACK 500A
93294	POWERSAFE.GERÄTESTECKER.L3.GR.500A.M12	Powersafe connector L3 GREY 500A
93295	POWERSAFE.GERÄTESTECKER.N.BL.500A.M12	Powersafe connector N BLUE 500A
93296	POWERSAFE.GERÄTESTECKER.PE.GN.500A.M12	Powersafe connector PE GREEN 500A

Protection cap appliance inlet

EDP No.	Product-ID-No.	Description
93298	POWERSAFE.GERÄTESTECKER.SCHUTZKAPPE.L1	Powersafe Protective cap for connector
93299	POWERSAFE.GERÄTESTECKER.SCHUTZKAPPE.L2	Powersafe Protective cap for connector
93300	POWERSAFE.GERÄTESTECKER.SCHUTZKAPPE.L3	Powersafe Protective cap for connector
93301	POWERSAFE.GERÄTESTECKER.SCHUTZKAPPE.N	Powersafe Protective cap for connector
93302	POWERSAFE.GERÄTESTECKER.SCHUTZKAPPE.PE	Powersafe Protective cap for connector

Flange gasket socket / appliance inlet

EDP No.	Product-ID-No.	Description
93303	POWERSAFE.STD.GS.FLANSCHDICHTUNG	Powersafe flange gasket

Single pole high current connector - Powersafe

Plug 150 mm²

EDP No.	Product-ID-No.	Description
93305	POWERSAFE.STECKER.L1.BR.500A.150MM ²	Powersafe plug L1 BROWN 500A DM15-28MM
93306	POWERSAFE.STECKER.L2.SW.500A.150MM ²	Powersafe plug L2 BLACK 500A DM15-28MM
93308	POWERSAFE.STECKER.L3.GR.500A.150MM ²	Powersafe plug L3 GREY 500A DM15-28MM
93309	POWERSAFE.STECKER.N.BL.500A.150MM ²	Powersafe plug N BLUE 500A DM15-28MM
93311	POWERSAFE.STECKER.PE.GN.500A.150MM ²	Powersafe plug PE GREEN 500A DM15-28MM

Plug 240 mm²

EDP No.	Product-ID-No.	Description
93312	POWERSAFE.STECKER.L1.BR.800A.240MM ²	Powersafe plug L1 BROWN 800A DM22-32MM
93313	POWERSAFE.STECKER.L2.SW.800A.240MM ²	Powersafe plug L2 BLACK 800A DM22-32MM
93314	POWERSAFE.STECKER.L3.GR.800A.240MM ²	Powersafe plug L3 GREY 800A DM22-32MM
93315	POWERSAFE.STECKER.N.BL.800A.240MM ²	Powersafe plug N BLUE 800A DM22-32MM
93316	POWERSAFE.STECKER.PE.GN.800A.240MM ²	Powersafe plug PE GREEN 800A DM22-32MM

Protection cap plug

EDP No.	Product-ID-No.	Description
93317	POWERSAFE.STECKER.SCHUTZKAPPE.L1	Powersafe Protection cap for plug
93318	POWERSAFE.STECKER.SCHUTZKAPPE.L2	Powersafe Protection cap for plug
93319	POWERSAFE.STECKER.SCHUTZKAPPE.L3	Powersafe Protection cap for plug
93320	POWERSAFE.STECKER.SCHUTZKAPPE.N	Powersafe Protection cap for plug
93321	POWERSAFE.STECKER.SCHUTZKAPPE.PE	Powersafe Protection cap for plug

Coupling 150 mm²

EDP No.	Product-ID-No.	Description
93322	POWERSAFE.KUPPLUNG.L1.BR.500A.150MM ²	Powersafe coupling L1 BROWN 500A DM15-28MM
93323	POWERSAFE.KUPPLUNG.L2.SW.500A.150MM ²	Powersafe coupling L2 BLACK 500A DM15-28MM
93324	POWERSAFE.KUPPLUNG.L3.GR.500A.150MM ²	Powersafe coupling L3 GREY 500A DM15-28MM
93325	POWERSAFE.KUPPLUNG.N.BL.500A.150MM ²	Powersafe coupling N BLUE 500A DM15-28MM
93326	POWERSAFE.KUPPLUNG.PE.GN.500A.150MM ²	Powersafe coupling PE GREEN 500A DM15-28MM

Coupling 240 mm²

EDP No.	Product-ID-No.	Description
93327	POWERSAFE.KUPPLUNG.L1.BR.800A.240MM ²	Powersafe coupling L1 BROWN 800A DM22-32MM
93330	POWERSAFE.KUPPLUNG.L2.SW.800A.240MM ²	Powersafe coupling L2 BLACK 800A DM22-32MM
93332	POWERSAFE.KUPPLUNG.L3.GR.800A.240MM ²	Powersafe coupling L3 GREY 800A DM22-32MM
93333	POWERSAFE.KUPPLUNG.N.BL.800A.240MM ²	Powersafe coupling N BLUE 800A DM22-32MM
93334	POWERSAFE.KUPPLUNG.PE.GN.800A.240MM ²	Powersafe coupling PE GREEN 800A DM22-32MM

Protection cap coupling

EDP No.	Product-ID-No.	Description
93335	POWERSAFE.KUPPLUNG.SCHUTZKAPPE.L1	Powersafe Protective cap for coupling
93336	POWERSAFE.KUPPLUNG.SCHUTZKAPPE.L2	Powersafe Protective cap for coupling
93337	POWERSAFE.KUPPLUNG.SCHUTZKAPPE.L3	Powersafe Protective cap for coupling
93338	POWERSAFE.KUPPLUNG.SCHUTZKAPPE.N	Powersafe Protective cap for coupling
93339	POWERSAFE.KUPPLUNG.SCHUTZKAPPE.PE	Powersafe Protective cap for coupling

Lock Key coupling / plug

EDP No.	Product-ID-No.	Description
93340	POWERSAFE.LOCK.KEY.STECKER.KUPPLUNG	Powersafe releasing key

Decontactors and plug connections 5A to 600A



DSN Decontactors

IP66/IP67 automatically when plugging

Industrial plug connections with integrated switching function, protection type IP66/IP67. The high international protection rating is automatically achieved when the plug is inserted or the lid is closed, without using more handles.

16 to 63A - up to 1000VAC and 250VDC.



PN plug connections IP66/IP67

Compact plug connections of protection type IP66/67, or heat-resistant.

As with all plug connections in this series, leak-tightness is automatically achieved when the plug is inserted or the lid is closed, without using other handles.

There are model available which are heat-resistant up to 240°C (IP54). 30A up to 500VAC and 130VDC.



DS Decontactors and plug connections

The quality standard for the processing industry

The model with the most comprehensive range of services.

It covers the range from 16 to 400A (decontactors that are separable under load up to 250A) and is available in metal (from 63A) and offers a variety of options.

16 to 400A - up to 1000VAC and 250VDC.

Decontactors and plug connections 5A to 600A



DXN/DX Decontactors

ATEX, "de" explosion protection

Explosion-proof plug connections with "de" explosion protection, as per the ATEX Directive 94/9/EC and the ATEX guidelines. The DXN and DX series can be used in Zones 1 and Zone 2 (gas) and Zones 21 and 22 (dust).

16 to 125A - up to 750VAC and 250VDC.



Self-ejecting systems - Rettbox®/Rettbox®-air

Automatic Isolation function

Self-ejecting systems can be triggered mechanically or by means of an automatic isolating function on start-up. Available with or without integrated compressed air unit.



CS / SP / CCH

High current connector, single-pole connectors up to 700A and charging couplers.

CONTACT US

Subject to technical changes 03/2021/1.0



GIFAS
ELECTRIC

GIFAS ELECTRIC
Gesellschaft m.b.H
Strass 2
5301 Eugendorf
AUSTRIA

🌐 www.gifas.at
✉ verkauf@gifas.at
☎ +43 6225/7191-0
☎ +43 6225/7191-561
☎ +49 8654/404-2000